

GRIP FORCE MEASUREMENT OF SOFT-ACTUATED FINGER EXOSKELETON

I. N. A. M. Nordin^a, A. A. M. Faudzi^{a,b,c*}, M. Z. Kamarudin^a, Dyah Ekashanti Octorina Dewi^{c,d}, Tariq Rehman^a, M. R. M. Razif^a

^aControl and Mechatronics Engineering Department, Faculty of Electrical Engineering, Universiti Teknologi Malaysia, 81310 UTM Johor Bahru, Johor, Malaysia

^bCenter for Artificial Intelligence and Robotics (CAIRO), Universiti Teknologi Malaysia, 81310 UTM Johor Bahru, Johor, Malaysia

^cIJN-UTM Cardiovascular Engineering Center, Institute of Human Centred Engineering, Universiti Teknologi Malaysia, 81310 UTM Johor Bahru, Johor, Malaysia

^dDepartment of Clinical Science, Faculty of Biosciences and Medical Engineering, Universiti Teknologi Malaysia, 81310 UTM Johor Bahru, Johor, Malaysia

Article history

Received

3 November 2015

Received in revised form

24 March 2016

Accepted

24 March 2016

*Corresponding author
athif@fke.utm.my

Graphical abstract



Abstract

Over recent years, the research in the field of soft actuation has been extensively increased for achieving more complex motion path with smooth, high flexible movement and high generated force at minimum operating pressure. This paper presents the study on gripping force capability of soft actuators applied on glove-type finger exoskeleton, developed in motivation to assist individuals having weak finger gripping ability in their rehabilitation exercise towards hand function restoration. The exoskeleton utilizes five cylindrical shaped pneumatic bending actuators developed in the lab, which use fiber reinforcement as a cause of bending motion that drive finger's flexion movement. Four right-handed healthy volunteers simulated paralysis participated in the study. At 200kPa safe operating pressure, the soft exoskeleton worn by the subjects demonstrates the ability to provide adequate grip force. The grip force generated from exoskeleton worn on passive right hand is 4.66 ± 0.2 N and 3.61 ± 0.2 N from passive left hand, both higher than the minimum grip forces measured to hold the Hand Dynamometer of 240 g. It shows good potential to be used as a finger rehabilitation assist device.

Keywords: Finger exoskeleton; soft robotic glove; soft actuator; pneumatic rubber actuator

© 2016 Penerbit UTM Press. All rights reserved

1.0 INTRODUCTION

From the statistic of National Stroke Association of Malaysia (NASAM), stroke is the third largest cause of death in Malaysia [1]. Nearly 40,000 people in Malaysia suffer from stroke every year, in most cases affecting adults compared to children. Paralysis, the common disabilities resulting from stroke which may involve

complete or partial disability in body movement, affecting the stroke survivors in their daily activities, such as walking and grasping objects. Through the use of rehabilitation exercises and equipments at early stages of paralysis, the brain can be trained to regain those forgotten body movements significantly much faster. With aid from robotic devices, it might promote a cost-effective therapy for stroke survivors to maintain

their movement ability after receiving standard in hospital rehabilitation.

Rehabilitation device specifically design for restoring hand function must be able to at least provide the most important motion to the finger; e.g. flexion motion. Several studies in developing finger actuation device for assisting stroke survivors in motor skills function restoration have been conducted [2]–[5]. Different approaches are extensively being studied for causing the bending motion to follow finger flexion motion. Whether they are pneumatic or hydraulic-based actuator, the actuators have been developed based on bellow structure [6], [7], integration of bellows structure with strain limiting layer [5], fiber braided reinforcement [8]–[11], and integration of fiber braided reinforcement with strain limiting layer [3]. Most of the actuators shows promising bending capability at safe operating pressure until 500 kPa for pneumatic driven [4], [5], [12] and until 345 kPa for hydraulic driven [13].

In addition to bending capability, grip assistance produced by the finger exoskeleton should be enough to assist the stroke survivors in their rehabilitation exercises. Not more than 15 N grasping forces of healthy subjects was reported to manipulate objects that are encountered during Activities of Daily Living (ADL) [14], while the grasping force for individuals with different severity of hand impairments is very small, some almost close to zero [15]. A finger soft exoskeleton should provide grasping force that is adequate to assist ADL, which varies between 0.1 N to 15 N depending on the weight of the objects.

Other factor contributing to the grip assistance produced is the material of the actuator interfacing human body. Glove is usually being used as the attachment between the actuator and fingers for optimum force transmission [6], [13], [16]. Glove-type soft exoskeleton presented in this paper utilized the potential fiber reinforced soft bending actuators to drive the finger's flexion motion. This paper presents the evaluation of our first prototype of finger exoskeleton, operated until 200 kPa of air pressure tested on the grip force by healthy simulated paralysis subjects.

2.0 SOFT EXOSKELETON DESIGN AND CONTROL

2.1 Braided Bending-type Actuator

The actuators used for actuating the flexion motion of the finger were fabricated from two rubber layers, the inner and the protective outer layer that were made from silicone rubber, KE-1603 A/B from Shin-Etsu. A braided fiber layer composed from Aramid fiber was positioned around the inner rubber layer to restrict expansion in radial direction. The fibers were knitted in two patterns, each covering half of cylindrical segments as can be seen in Figure 1. The 90° fibers shown by the green segment box on the left side of the cylindrical actuator have contributed in the extension motion of the actuator while the red segment on the

right side of the actuator that shows the knitted fibers of 35° fiber angle has lead to contraction motion, thus induced bending motion. A small tube was inserted and mounted at the top of the actuator to enable the air pressure input supply.

The actuator fabrication method of combining two fiber angles of extension and contraction characteristics, represented by fibers of 90° and 35° was proven to successfully produce bending motion. A very smooth curling trajectory of the actuator's tip is demonstrated in Figure 2.

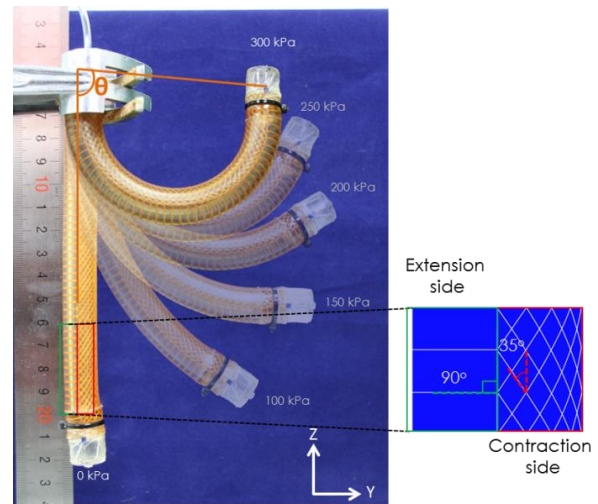

Figure 1 Construction of soft actuator braided with two different characteristics of fiber angles

By referring to Figure 3, 84.66° bending angle, θ , is shown through experimental testing when operated at 300 kPa air pressure. The bending angle increases linearly as the pressure increases. R-squared measures from the linear trend line is 0.995 (very close to 1), explain a good fit of linear model shown by the graph.

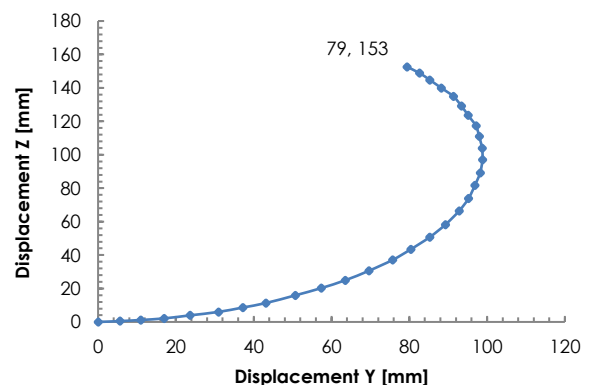

Figure 2 Trajectory of actuator's tip (tip was shown in blue marker in Figure 1)

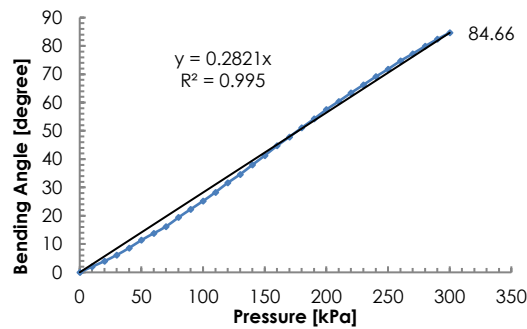

Figure 3 Bending angle of actuator as the pressure increases

2.2 Glove Design & Actuator Integration

Five soft actuators of the same design characteristics were fabricated to fit five fingered comfortable neoprene glove attachment, positioned along the top surface of fingers and thumb, as shown in Figure 4. Rubber bands were incorporated to the glove to fix the actuators on the fingers bones and joints. Velcro strap was placed around the forearm to prevent the unwanted movement from the air tubes. Velcro tape at the wrist will perfect the fitting of the glove to the user's hand. Another same structure of the glove is used for right hand.

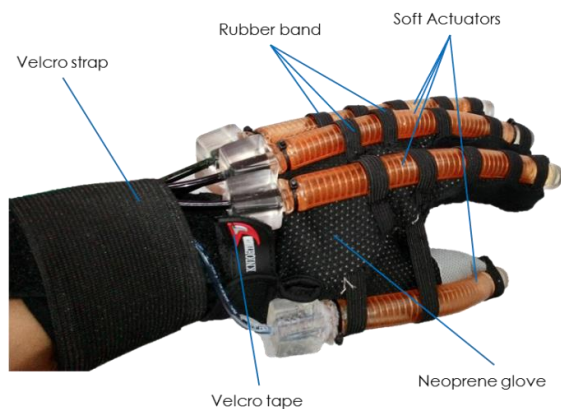

Figure 4 The prototype showing the soft actuator attachment to the glove for the left hand

2.3 Control System Overview

Air is pressurized by the air compressor, transferred by pneumatic tubes and push buttons were used to activate the desired amount of air pressure supplied to the soft actuators. The amount of air pressure supplied to the exoskeleton was regulated by using on-off valve. A microcontroller was programmed to have a five selections of pressure supply, 100 kPa, 150 kPa, 200 kPa, 250 kPa and 300 kPa. The control box is powered from wall mounted power source of 24 V. The workflow of the system can be summarized as in Figure 5.

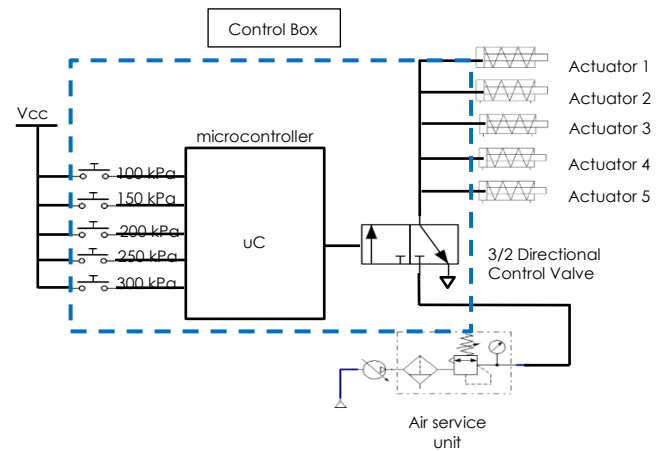

Figure 5 Schematic diagram of the soft exoskeleton system

Figure 6 shows the control box of the system. In case of any emergency condition, the emergency button to stop the operation in case of any malfunction of the exoskeleton is located on further right on top of the box.

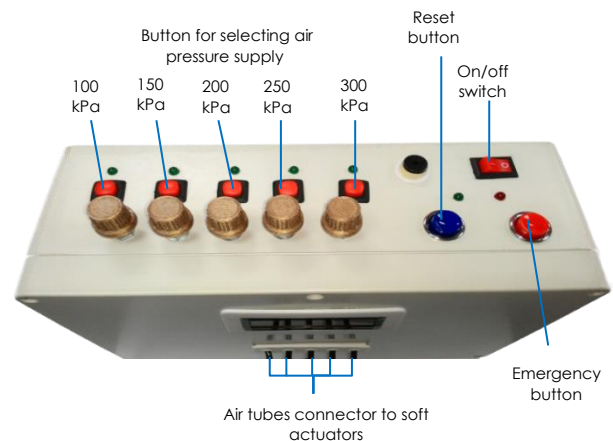

Figure 6 Control box

2.4 Grip Test Setup

Grip force test was conducted to assess the efficiency of the soft exoskeleton in providing gripping strength to simulated paralyzed hands. A digital Hand Dynamometer HD-BTA (Vernier Lab) used by researchers in conducting grip strength measurement [17]–[20] was used in this study. The sensor is an isometric force sensor (strain gauge amplifier-based) that sense the force applied to its pressure pads. It is connected the device interface, Vernier LabQuest® 2 and connected to the laptop for better visualizing of the output by using Logger Lite software.

Grip test was performed on four healthy subjects from a mixed sample of university students, composed of two males and two females (weight 45-70 kg, aged from 20-27 years). Volunteer exclusion criteria include left hand as the dominant hand, neurological disorder, stroke survivors, injured hands and disable people. Two experiments were conducted, grip forces were taken

from subjects without wearing the soft exoskeleton (in Experiment A) and with wearing the soft exoskeleton (in Experiment B). In Experiment A, all subjects were asked to grip the hand dynamometer just enough for holding the gauge. The results of Experiment A were presented in Section 3.1.

In Experiment B, the subjects were simulated paralysis by being totally passive during the force measurement. The soft actuators that actuate the flexion movement of fingers were controlled by selecting the modes of operation at three different input pressure: 100 kPa, 150 kPa and 200 kPa. Pressure 250 kPa and 300 kPa were excluded in the measurement to comply with safety regulation. The maximum compressed air given or in direct contact with the skin, as regulated by United States OSHA (Occupational Safety and Health Administration) in 1910.242.b is 210 kPa (30 psi). The results were tabulated in Section 3.2.

To achieve a paralyzed condition, subjects were asked to close their eyes, sat on a chair with relaxed back and arm, feet flat on the ground and arm supported by the chair armrest, perpendicular to the body. Figure 7 shows the gripping posture following the manual of Vernier Hand Dynamometer, in measuring the grip force of both experiments. The hand dynamometer held in a vertical position and should not in contact with anything else except the finger.



Figure 7 Standard position of hand grip test measurement. The hand dynamometer was weighted as 240 grams equivalent to 240 ml bottled mineral water.

3.0 RESULTS AND DISCUSSION

3.1 Grip Force from Experiment A

The data recorded by the hand dynamometer were collected by Vernier LabQuest® 2 interface and displayed by the Logger Lite software. Figure 8 shows a trial of continuous initiative grip forces acquired by the right hand of one subject to hold the hand dynamometer.

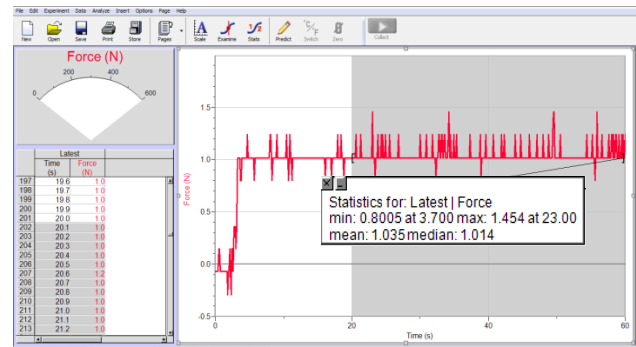

Figure 8 Vernier Logger Lite software interface showing continuous grip force

Three continuous grip trials were measured for subjects's both right and left hands. Every trial was conducted in 60 s, but were analyzed in the last 40 s (samples of data highlighted in gray) when the outputs are more stable. The mean grip force to hold the hand dynamometer calculated from the data gained from their right hand is 1.15 ± 0.2 N and from left hand is 0.98 ± 0.2 N.

3.2 Grip Force from Experiment B

The grip force of hand assisted by the soft exoskeleton was measured 6 times per subject per operating pressure. The statistics for every grip trials were obtained by moving the brackets to the ranges of each plateau gained. The box shown in Figure 9 contains the statistical data (min, max, mean and median). The mean value of one plateau (at the peak) was tabulated as grip force of one trial.

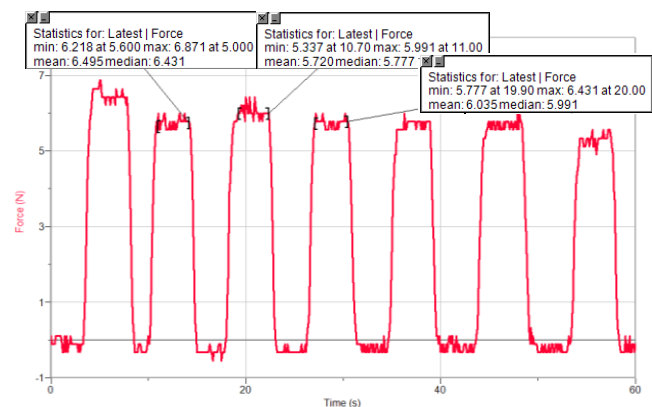

Figure 9 Grip forces measured at 200 kPa supplied air pressure of Subject 1's right hand.

The mean grip forces were recorded to the nearest 0.1 N as shown in Table 1, 2 and 3. The measurement were collected at both left and right hands. Six gripping trials were recorded per hand at three different operating pressure, 100 kPa in Table 2, 150kPa in Table 3 and 200 kPa in Table 4.

Table 1 Grip force at 100kPa operating air pressure

Grip Force by Left Exoskeleton				
	Subject 1	Subject 2	Subject 3	Subject 4
Trial 1	0.62	0.63	0.86	1.14
Trial 2	0.65	0.66	0.87	0.91
Trial 3	0.58	0.73	0.93	0.92
Trial 4	0.72	0.79	1.10	1.06
Trial 5	0.67	0.81	1.07	0.94
Trial 6	0.60	0.87	1.11	1.03
Mean (SD)	0.64(0.05)	0.75(0.09)	0.99(0.12)	1.00(0.09)
Mean (SD) Population	0.84 (0.16)			
n				
Grip Force by Right Exoskeleton				
	Subject 1	Subject 2	Subject 3	Subject 4
Trial 1	1.55	0.76	0.77	1.55
Trial 2	1.48	0.74	0.81	1.48
Trial 3	1.52	0.74	0.78	1.52
Trial 4	1.42	0.63	0.77	1.42
Trial 5	1.26	0.64	0.81	1.26
Trial 6	1.42	0.64	0.78	1.42
Mean (SD)	1.44(0.10)	0.69(0.06)	0.79(0.02)	1.44(0.10)
Mean (SD) Population	1.09 (0.35)			
n				

^aSD represents Standard Deviation.

Table 2 Grip force at 150kPa operating air pressure

Grip Force by Left Exoskeleton				
	Subject 1	Subject 2	Subject 3	Subject 4
Trial 1	1.39	0.97	1.94	2.07
Trial 2	1.50	0.92	1.90	2.08
Trial 3	1.33	1.11	1.91	2.02
Trial 4	1.51	0.89	1.96	1.93
Trial 5	1.80	0.81	1.92	1.95
Trial 6	1.90	0.88	1.96	1.91
Mean (SD)	1.57(0.23)	0.93(0.10)	1.93(0.03)	1.99(0.07)
Mean (SD) Population	1.61 (0.42)			
n				
Grip Force by Right Exoskeleton				
	Subject 1	Subject 2	Subject 3	Subject 4
Trial 1	3.82	3.09	2.97	1.38
Trial 2	3.58	3.26	2.87	1.50
Trial 3	3.64	3.40	2.85	1.52
Trial 4	3.72	2.99	3.03	2.16
Trial 5	3.70	3.14	2.97	2.04
Trial 6	3.51	3.11	3.07	2.09
Mean (SD)	3.66(0.11)	3.17(0.14)	2.96(0.09)	1.78(0.35)
Mean (SD) Population	2.89 (0.69)			
n				

Table 3 Grip force at 200kPa operating air pressure

Grip Force by Left Exoskeleton				
	Subject 1	Subject 2	Subject 3	Subject 4
Trial 1	3.39	3.52	3.66	4.17
Trial 2	3.46	3.55	3.51	3.73

Trial 3	3.82	3.42	3.61	3.53
Trial 4	3.81	3.71	3.02	3.66
Trial 5	3.89	3.83	3.32	3.70
Trial 6	3.88	3.88	3.03	3.67
Mean (SD)	3.71(0.22)	3.65(0.19)	3.36(0.28)	3.74(0.22)
Mean (SD) Population	3.61 (0.15)			
n				
Grip Force by Right Exoskeleton				
	Subject 1	Subject 2	Subject 3	Subject 4
Trial 1	6.50	4.10	4.10	4.53
Trial 2	5.72	3.62	4.47	4.69
Trial 3	6.04	3.72	4.03	4.80
Trial 4	5.73	3.38	4.03	5.15
Trial 5	5.71	3.60	3.83	5.39
Trial 6	5.71	3.83	3.37	5.73
Mean (SD)	5.90(0.32)	3.71(0.24)	3.97(0.36)	5.05(0.46)
Mean (SD) Population	4.66 (0.88)			
n				

Figure 10 shows the average force of passive hand assisted by hand exoskeleton in several conditions of air pressure supply. Red bar represents the forces measured from right hand and blue bar from left hand. The reference value of the minimal force to grip the hand dynamometer as described in Experiment A are presented by the dashed line in blue represents the reference value of grip force measured on the left hand (0.98 N), and the red line on the right hand (1.15 N).

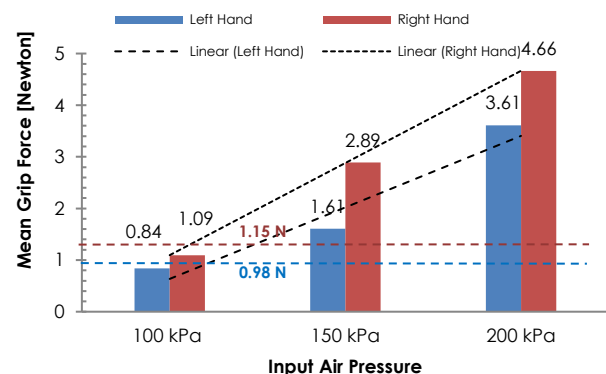

Figure 10 Mean Grip Force of whole population.

From the results, the gripping forces produce by the exoskeleton worn on right hand (1.09 N) and left hand (0.84 N) at operating pressure of 100 kPa are inadequate to hold a 240 g hand dynamometer. Sufficient gripping force can be achieved when the actuators were supplied 150 kPa and more. In all cases, the forces shown by right hand are higher than the left hand. The difference is ranging from (0.25 - 1.28 N) which might be due to the unintended force initiated by their dominant right hand.

Considering the grip force measured from left hand exoskeleton as the reference to evaluate the effectiveness in gripping, the grip force shown (1.61 N to 3.61 N) that can be achieved at 150 kPa- 200 kPa

operating pressure proved that the soft exoskeleton is applicable to be used in assisting lightweight task. From the plots in Figure 10, the grip force is directly proportional with increase in air pressure.

4.0 CONCLUSION

This paper has presented a lightweight exoskeleton driven by soft bending actuators and its performance in actuating healthy subject's finger flexion motion. From the data of four healthy subjects participated in the study, results showed that the soft exoskeleton has a significant effect on the grip force. 3.61 N of grip force at 200 kPa operating input pressure is sufficient to hold lightweight objects. It shows some potential to provide assistance in gripping.

Future works will include optimization works of the actuator design in achieving higher gripping forces at lower air operating pressure and higher degree-of-freedom (DOF) that includes finger abduction/adduction movement. The control system will be improvised to independently control of each finger.

Acknowledgement

The authors would like to thank Universiti Teknologi Malaysia (UTM) and Ministry of Higher Education Malaysia (MOHE) under FRGS Grants R.J130000.7809.4F371 and R.J130000.7809.4F682 for financial and facilities support.

References

- [1] National Stroke Association of Malaysia. [Online]. From: <http://www.nasam.org/> [Accessed from 1 Nov 2015]
- [2] Polygerinos, P., K. C. Galloway, E. Savage, M. Herman, K. O. Donnell, and C. J. Walsh. (2015). Soft Robotic Glove for Hand Rehabilitation and Task Specific Training, *IEEE International Conference on Robotics and Automation (ICRA)*. Washington, USA. 26-30 May 2015. 2913-2919.
- [3] Galloway, K. C., P. Polygerinos, C. J. Walsh, and R. J. Wood. (2013). Mechanically Programmable Bend Radius for Fiber-reinforced Soft Actuators. *16th International Conference on Advanced Robotics (ICAR)*. Montevideo, Uruguay, 25-29 Nov 2013, 1-6.
- [4] Sasaki, D., T. Noritsugu, H. Yamamoto, and M. Takaiwa. 2004. Wearable Power Assist Device for Hand Grasping Using Pneumatic Artificial Rubber Muscle. *SICE Annual Conference*. Sapporo, Japan. 4-6 August 2004. 655-660.
- [5] Noritsugu, T., M. Takaiwa, and D. Sasaki. 2008. Power Assist Wear Driven with Pneumatic Rubber Artificial Muscles. *15th International Conference on Mechatronics and Machine Vision in Practice, 2008*. Auckland, New Zealand. 2-4 Dec 2008. 539-544.
- [6] Polygerinos, P., S. Lyne, L. F. Nicolini, B. Mosadegh, G. M. Whitesides, and C. J. Walsh. 2013. Towards a Soft Pneumatic Glove for Hand Rehabilitation. *IEEE/RSJ International Conference on Intelligent Robots and Systems*. Tokyo, Japan. 3-7 Nov 2013. 1512-1517.
- [7] Wakimoto, S., K. Suzumori, and K. Ogura. 2011. Miniature Pneumatic Curling Rubber Actuator Generating Bidirectional Motion with One Air-Supply Tube. *Advanced Robotics, The International Journal of the Robotics Society in Japan*. 25(9-10):1311-1330.
- [8] Nordin, I. N. A. M., A. A. M. Faudzi, M. R. M. Razif, E. Natarajan, S. Wakimoto, and K. Suzumori. 2014. Simulations of Two Patterns Fiber Weaves Reinforced in Rubber Actuator. *Jurnal Teknologi*. 69(3): 133-138.
- [9] Nordin, I. N. A. M., M. R. M. Razif, A. A. M. Faudzi, E. Natarajan, K. Iwata, and K. Suzumori. 2013. 3-D Finite-Element Analysis of Fiber-reinforced Soft Bending Actuator for Finger Flexion. *IEEE/ASME International Conference on Advanced Intelligent Mechatronics*. Wollongong, Australia. 9-12 July 2013. 128-133.
- [10] Faudzi, A. A. M., M. R. M. Razif, I. N. A. M. Nordin, K. Suzumori, S. Wakimoto, and D. Hirooka. 2012. Development of Bending Soft Actuator with Different Braided Angles. *IEEE/ASME International Conference on Advanced Intelligent Mechatronics*. Koahsiung, Taiwan. 11-14 July 2012. 1093-1098.
- [11] Nordin, I. N. A. M., A. A. M. Faudzi, S. Wakimoto, K. Suzumori. 2015. Simulations of Fiber Braided Bending Actuator: Investigation on Position of Fiber layer Placement and Air Chamber Diameter. *10th Asian Control Conference (ASCC)*. Sabah, Malaysia. 31 May- 3 June 2015. 4-8.
- [12] Noritsugu, T., D. Sasaki, and M. Takaiwa. 2003. Artificial Pneumatic Rubber Muscles to a Human Friendly Robot. *IEEE International Conference on Robotics and Automation*. Taipei, Taiwan. 14-19 Sept 2003. 2188-2193.
- [13] Polygerinos, P., Z. Wang, K. C. Galloway, R. J. Wood, and C. J. Walsh. 2014. Soft Robotic Glove for Combined Assistance and at-Home Rehabilitation. *Journal of Robotics and Autonomous Systems*. 73 :135-143.
- [14] Matheus, K. and A. M. Dollar. 2010. Benchmarking Grasping and Manipulation: Properties of the Objects of Daily Living. *2010. IEEE/RSJ 2010 International Conference on Intelligent Robots and Systems (IROS)*. 18-22 Oct 2010. 5020-5027.
- [15] Dovat, L., O. Lambercy, R. Gassert, T. Maeder, T. Milner, T. C. Leong, and E. Burdet. 2008. HandCARE: A cable-actuated Rehabilitation System to Train Hand Function After Stroke. *IEEE Trans. Neural Syst. Rehabil. Eng.*, 16(6): 582-591.
- [16] Noritsugu, T., M. Takaiwa, and D. Sasaki. 2008. Development of Power Assist Wear using Pneumatic Rubber Artificial Muscles. *Asia International Symposium on Mechatronics*. Sapporo, Japan. 27-31 Aug 2008. 371-375.
- [17] Widia, M. and S. Z. Dawal. 2010. Investigation on Upperlimb Muscle Activity and Grip Strength During Drilling Task. *International MultiConference of Engineers and Computer Scientists Vol III IMECS*. Hong Kong. 17-19 March 2010. 1953-1957.
- [18] Sidek, S. N. and A. J. Haja Mohideen. 2012. Mapping of EMG signal to Hand Grip Force at Varying Wrist Angles. *2012. IEEE EMBS Conference on Biomedical Engineering and Sciences (IECBES)*. Langkawi, Malaysia. 17-19 Dec 2012. 648-653.
- [19] Heck, S., C. Zilleken, D. Pennig, and T. C. Koslowsky. 2012. Reconstruction of Radial Capitellar Fractures using Fine-threaded Implants (FFS). *Injury*. 43(2):164-168.
- [20] Krause, K. E., E. I. McIntosh, and L. A. Vallis. 2012. Sarcopenia and Predictors of the Fat Free Mass Index in Community-Dwelling and Assisted-Living Older Men and Women. *Gait & Posture*. 35(2): 180-185.