

Modeling and Control of a Nonlinear Active Suspension Using Multi-Body Dynamics System Software

M. Fahezal Ismail^{a*}, Y. M. Sam^b, S. Sudin^b, K. Peng^c, M. Khairi Aripin^d

^aIndustrial Automation Section, Universiti Kuala Lumpur Malaysia France Institute, 43650 Bdr. Baru Bangi, Selangor, Malaysia

^bFaculty of Electrical Engineering, Universiti Teknologi Malaysia, 81310 UTM Skudai, Johor, Malaysia

^cTemasek Laboratories, National University of Singapore, Singapore 117411, Singapore

^dFaculty of Electrical Engineering, Universiti Teknikal Malaysia Melaka, 76100 Durian Tunggal, Melaka, Malaysia

*Corresponding author: fahezal@mfi.unkl.edu.my

Article history

Received :17 September 2013

Received in revised form :

26 December 2013

Accepted :30 January 2014

Graphical abstract

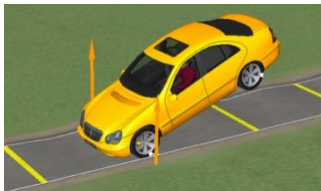

Virtual animation by CarSim for passive suspension system.



Virtual animation by CarSim for active suspension system with CCNF.

Abstract

This paper describes the mathematical modeling and control of a nonlinear active suspension system for ride comfort and road handling performance by using multi-body dynamics software so-called CarSim. For ride quality and road handling tests the integration between MATLAB/Simulink and multi-body dynamics system software is proposed. The control algorithm called the Conventional Composite Nonlinear Feedback (CCNF) control was introduced to achieve the best transient response that can reduce to overshoot on the sprung mass and angular of control arm of MacPherson active suspension system. The numerical experimental results show the control performance of CCNF comparing with Linear Quadratic Regulator (LQR) and passive system.

Keywords: Nonlinear active suspension; ride comfort; road handling; conventional composite nonlinear feedback control; linear quadratic regulator; control algorithm

Abstrak

Kertas ini menerangkan model matematik dan kawalan sistem penggantungan tak linear aktif untuk keselesaan perjalanan dan jalan prestasi pengendalian dengan menggunakan perisian dinamik multi-badan yang dipanggil CarSim. Untuk kualiti pemanduan dan pengendalian jalan menguji integrasi antara MATLAB/Simulink dan pelbagai badan perisian sistem dinamik adalah dicadangkan. Algoritma kawalan dipanggil Komposit Konvensional Linear Maklumbalas (CCNF) kawalan telah diperkenalkan untuk mencapai keputusan yang terbaik sementara yang boleh mengurangkan terlajak jisim badan kereta dan sudut bagi lengan kawalan. Keputusan eksperimen berangka menunjukkan prestasi kawalan CCNF membandingkan dengan Kawalan Linear Kuadratik (LQR) dan sistem pasif.

Kata kunci: Penggantungan aktif tak linear; keselesaan pemanduan; pengendalian jalan raya; komposit kawalan maklum balas tak linear konvensional; kawalan linear kuadratik, kawalan algoritma

© 2014 Penerbit UTM Press. All rights reserved.

1.0 INTRODUCTION

Performances in feedback control systems are often been specified in terms of the step response. For a fast response, a small overshoot ratio, however it will increase the overshoot. The influential idea of the Conventional Composite Nonlinear Feedback (CCNF) control [1]. In CCNF primarily damping ratio is kept very low to ensure fast response and as output approaches the expected force resulting from the road point system is made very much damped to avoid overshoot. The CCNF was proposed by G.Y. Chen in [2]. B.M. Chen research work explores the design of Conventional Composite Nonlinear Feedback (CCNF) control law for a Hard Disk Drive (HDD) servo mechanism system for tracking the reference signal [3]. X. Yu proposed Optimal CNF to control the gantry crane system as fast as possible without any overshoot while the load is limited in a specified swaying angle [4]. The active suspension systems were established over the last decades and a lot of papers have been published. Most of the papers focus on the transient response of the expected force resulting from the road disturbance in the various vehicle conditions as mention by D. Hrovat [5]. The current research work by M. Fahezal Ismail the application of DC motor transient vehicle active suspension system was used the CCNF as a performance in tracking the general speed XY table controller. The CCNF is successfully applied to improve the suspension deflection velocity of car body and velocity of car wheel form very high overshoot and fast rising time. A control

performance comparison between a nonlinear and linear active suspension systems done [6, 7]. However, the simulation works in a limited in a MATLAB / Simulink. There are various control techniques have been used in previous research work in an active suspension system. Y.M. Sama proposed the sliding mode control technique with proportional integral sliding surface and the LQR controller for control performance control algorithm used to reduce steady state error occurs in an active suspension system [8]. H. Abu proposed Infiniti control strategy as a robust control to the active suspension system [9]. A. Abu Khudhair et al and M.B.A Abdelhadi proposed fuzzy logic control to improve ride comfort and road handling performance [10]. X. Zhao et al discussed generally body acceleration based on ISO 2631 standard. The results show that the sprung mass of the vehicle was a larger influence on the vibration intensity [12]. X. D. Xue et al. did a study on the typical vehicle suspension system consisting of the two degrees of freedom. The quarter car model vehicle suspension can be classified as an active suspension system, semi-active suspension system or passive system [13]. Sanduet al developed a multi-body dynamics model of a quarter car test rig equipped with MacPherson strut suspension and applied a system identification technique. The MacPherson strut nonlinearity came from the magnitude angle change it experiences through its time. The greater the angle change, the greater the nonlinearity [14]. T. Shim et al discussed on the roll dynamics that strongly influenced by suspension properties such as roll centre height, roll, and roll camber. The effects of suspension properties on vehicle roll response have been investigated using multi-body vehicle dynamics software. The experimental results can be useful in initial suspension design for rollover prone vehicles, in particular, sports utility vehicles and trucks [15]. B.C. Chen et al proposed sliding mode control (SMC) for semi-active suspensions to achieve ride comfort and handling performance simultaneously. The author(s) claimed that SMC could reduce the sprung mass acceleration increasing tyre deflection [16]. V. Jun proposed Infiniti controller for a full vehicle suspension system to improve ride comfort and steady state handling performance. Based on the results, the author(s) claimed that the proposed controller improved handling without sacrificing vehicle cornering stability. M. Kaleemullah et al study on control performance of LQR, Fuzzy and Infiniti for active suspension system quarter car model. The authors claim the proposed controller is better than passive system as results shown from the simulation. Choudhry et al discuss on the fundamental for experimental measurement of base dynamic parameters and the application of base dynamic parameter estimation techniques in suspension [17]. S. Watanabe et al study on mechanical and control design variable geometry active suspension system. The authors also proposed PD controller and neural network as control performance comparison. Neuro control is better than PD controller based on the obtained results [21]. D.A Crolla et al presented a state observer design for adaptive vehicle suspension. Two main issues have been investigated issues, (1) the selection of measurement relation to estimation and sensors need, and (2) the variations in both road profiles and vehicle parameters estimation accuracy [22]. D. A. Crolla et al proposed Linear Quadratic Gaussian (LQG) for an active suspension. The LQG controller, incorporating a weighting controller, state observer and parameter estimator, was successful in adapting to road input conditions and also to vehicle parameters [23]. D. C. Chen recognized the need for improved understanding of links between subjective and objective measures of vehicle handling an extensive program of instrumented testing and driver evaluation was conducted with a view to correlating results from the different sets of data [24]. L. Jung Shan et al proposed nonlinear Backstepping controller for active suspensions system. The results show that the

2.0 SYSTEM MODELING

This section will explain details on a nonlinear active suspension based on the MacPherson strut. A quarter car mathematical modeling based on K.S. Horng et al [11]. The quarter car model is constructed based on the Newton's laws

$$m_s \ddot{z}_s + c_p(\dot{z}_s - \dot{z}_u) + k_s(z_s - z_u) = f_b - f_a \tag{1}$$

$$m_u \ddot{z}_u + c_p(\dot{z}_u - \dot{z}_s) + k_s(z_u - z_s) + k_t z_u = f_a \tag{2}$$

where

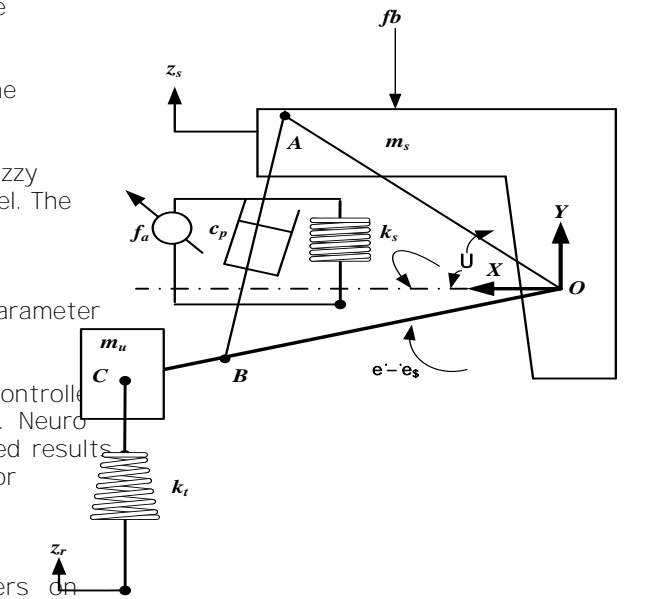

Figure 1 A free body diagram of a quarter car MacPherson strut model

Figure 1 shows a free body diagram of a quarter car MacPherson model. The model is similar to the actual active suspension system. Figure 1 consists of the sprung mass, which signifies the car chassis, while the unsprung mass, which signifies the wheel assembly. The stiffness of the car body spring, k_s and damping of the damper, c_p signify a passive spring and shock absorber that are placed between the car body and the wheel while stiffness of the car tire is the force applied in sprung

mass. This is an active force applied in active suspension systems. It is referred to road irregularities or road profiles. The distance from point O to point A is x . The distance from point O to point B is y . The state variables can be defined as follows:

3.1 Two Subsystem of Nonlinear Active Suspension System

The purpose of dividing the state equation in (4) is to reduce disturbance and to track the control variable. Then the system in equation (4) turns into:

$$\dot{x} = Ax + Bz \tag{3}$$

$$\dot{z} = Cz + Dv \tag{5}$$

$$\tag{4}$$

where

$$A = \begin{bmatrix} -\frac{c_1}{m_1} & \frac{c_1}{m_1} & 0 & 0 \\ \frac{c_1}{m_1} & -\frac{c_1}{m_1} & 0 & 0 \\ 0 & 0 & -\frac{c_2}{m_2} & \frac{c_2}{m_2} \\ 0 & 0 & \frac{c_2}{m_2} & -\frac{c_2}{m_2} \end{bmatrix}$$

$$B = \begin{bmatrix} 0 \\ 0 \\ \frac{1}{m_2} \\ -\frac{1}{m_2} \end{bmatrix}$$

$$C = \begin{bmatrix} 1 & 0 & 0 & 0 \\ 0 & 1 & 0 & 0 \\ 0 & 0 & 1 & 0 \\ 0 & 0 & 0 & 1 \end{bmatrix}$$

$$D = \begin{bmatrix} 0 \\ 0 \\ 0 \\ 0 \end{bmatrix}$$

where

$$\dot{z} = \begin{bmatrix} -\frac{c_1}{m_1} & \frac{c_1}{m_1} & 0 & 0 \\ \frac{c_1}{m_1} & -\frac{c_1}{m_1} & 0 & 0 \\ 0 & 0 & -\frac{c_2}{m_2} & \frac{c_2}{m_2} \\ 0 & 0 & \frac{c_2}{m_2} & -\frac{c_2}{m_2} \end{bmatrix} z + \begin{bmatrix} 0 \\ 0 \\ \frac{1}{m_2} \\ -\frac{1}{m_2} \end{bmatrix} v \tag{6}$$

$$\tag{7}$$

Based on [6, 7, and 11], there are some constraints that need to be considered in the mathematical modelling of the suspension model as follows:

1. Only vertical displacement for the sprung mass Z
2. θ is the angular displacement of the control arm. The arm linked to the car body is considered as an unsprung mass.
3. The value of vertical displacement and control arm will be measured from the static equilibrium point.
4. The sprung and unsprung masses are assumed to be two different elements.
5. The mass and control arm stiffness are ignored.
6. The forces are in the linear region for spring deflection, tire deflection and damping forces.

3.0 CONVENTIONAL COMPOSITE NONLINEAR FEEDBACK (CCNF) CONTROLLER DESIGN

The CCNF consists of linear control law and nonlinear control law. The state equation in (4) can be divided into two subsystems.

3.2 Linear Control Law

Equation (5) is used to design linear part in CCNF as follow to track the control variable .as follow:

$$\dots \dots \dots (8)$$

where

$$\dots \dots \dots (11)$$

$$\dots \dots \dots$$

For equation (6) the nonlinear feedback part as follows:

$$\dots \dots \dots (12)$$

with frequency of = 10 Hz and = 0.32 for quickly tracking. It can be checked that is asymptotically stable.

$$\dots \dots \dots$$

where as the reference .

For equation (6), the linear control law is designed as follows:

$$\dots \dots \dots (9)$$

where the item of is ignored in the linear control law as the reference .

is designed to remove the overshoot and in which is a solution of the Lyapunov equation given by

with frequency of Hz, the natural frequency of (6), and to reduce the disturbance with the small control signal. It can be checked that is asymptotically stable.

The complete CNF control law for equation (5) as follows,

3.3 Nonlinear Control Law

$$\dots \dots \dots (13)$$

For equation (5) the nonlinear part can be designed as follows:

$$\dots \dots \dots (10)$$

and for equation (6) as follows,

where

$$\dots \dots \dots$$

is to be designed. in which is a solution of the Lyapunov equation given by

4.0 RESULTS AND DISCUSSION

The numerical experiment is performed using the CarSim. Figure 2 shows the Simulink block used to design the control algorithm of CCNF and its integration with CarSim. All selected parameters are imported from CarSim and feed into Simulink to for CCNF controller design. In order to do a control performance for this numerical experimental, the LQR controller is defining as:

$$\dots \dots \dots (15)$$

where K is state feedback gain matrix. The complete LQR equation as follows:

$$\dots \dots \dots (16)$$

The matrix gain K is represented

$$(17)$$

The matrix P must satisfy the reduced-matrix Riccati equation.

$$(18)$$

Then the feedback regulator

$$(19)$$

In this research study, vertical acceleration is considered as a ride quality index. The criterion recommended by the International Standard Organization (ISO2631, 1985, 1989) provides the frequency weighting curve relating to vertical acceleration. The vertical weighting function is given in ISO2631. The weighted RMS vertical acceleration can be computed from the equation,

$$(4.2)$$

where a_w is the weighted vertical acceleration of a driver's seat. The vertical weighting function is given in ISO2631. Table 1 shows the relationship between the vertical acceleration level and the degree of comfort. Table 2 is shown as a parameter used in the simulation for CNF controller and passive system.

Table 1 RMS vertical acceleration level and degree of comfort (ISO2631-1, 1997)

RMS vertical acceleration level	Degree of comfort
(1) Less than 0.315 m/s ²	Not uncomfortable
(2) 0.315-0.63 m/s ²	A little uncomfortable
(3) 0.5-1 m/s ²	Fairly uncomfortable
(4) 0.8-1.6 m/s ²	Uncomfortable
(5) 1.25-2.5 m/s ²	Very uncomfortable
(6) Greater than 2 m/s ²	Extremely uncomfortable

Table 2 Physical parameters for quarter car model

Parameter	Value
Mass of a car body	455 kg
Mass of a car wheel	71 kg
Stiffness of a car body spring	17,659 N/m
Stiffness of a car tire	183,888 N/m
Damper coefficient	1950 Ns/m
Distance from point 0 to A	0.37 m
Distance from point 0 to B	0.64 m
Distance from point 0 to C	0.66 m

Before running the numerical experimental and numerical simulation in both environments in MATLAB/Simulink and CarSim, the initial setting must be done first in CarSim. Figure 3 shows the independent suspension kinematic screen for active suspension system setting. The physical parameters involved as shown in Table 2 is used. The kinematics of the suspension linkages is described by the lateral and longitudinal motions of the wheel as the suspension deflects vertically. The lateral movement primarily affects the transfer of tire lateral force of the body and the resulting body roll. The longitudinal movement primarily affects the transfer of tire longitudinal force of the body and the resulting body pitch. The motion of the wheels is defined by the positions of the wheel centre, and by camber and caster changes as each wheel moves in jounce.

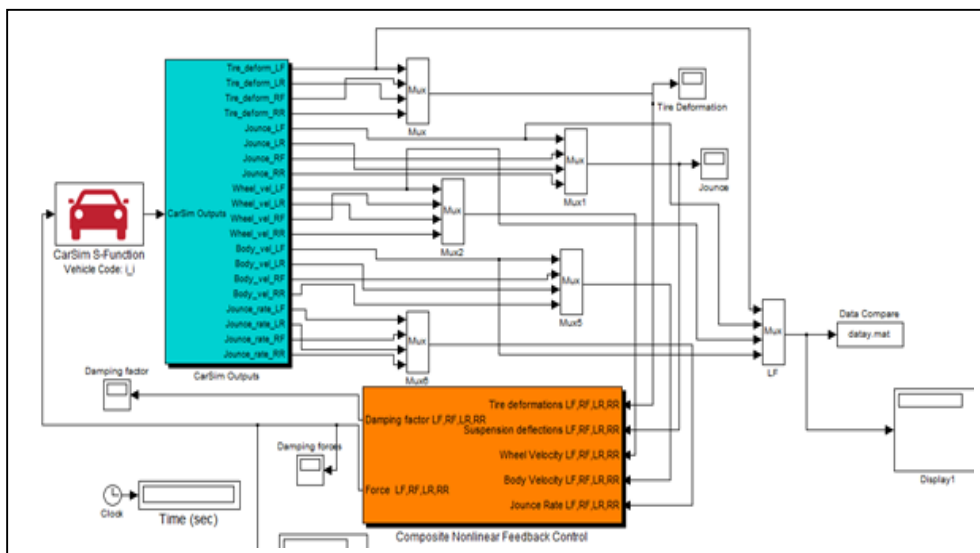

Figure 2 MATLAB/Simulink block diagram integrated with CarSim in CCNF

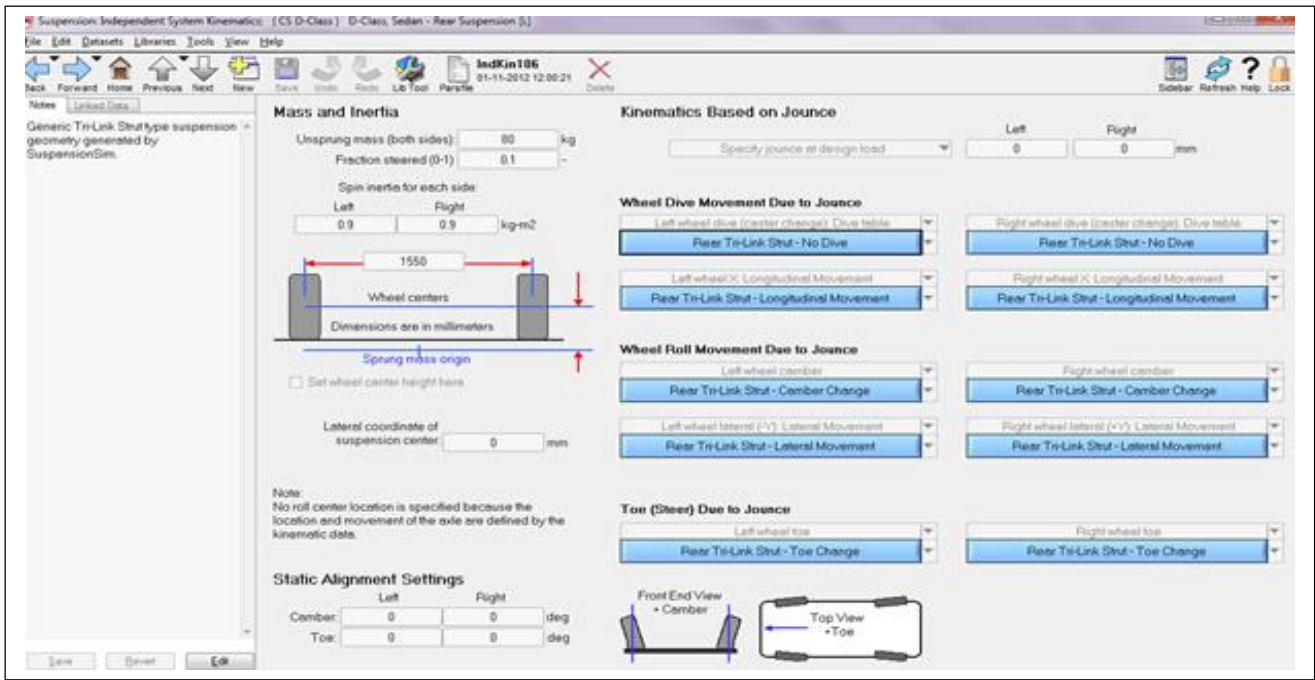

Figure 3 Control screen for active suspension parameter setup

The road profiles design also important factor to get the ride handling performance of the active suspension system. The result in Fig 10 shows that the best transient response came from CCNF controller compared to the LQR controller and passive system. The geometry and friction setting is the important parameters that give effect when the ride quality of active suspension system is running. The road profiles defined as a disturbance element in the CCNF controller design scheme. Fig 4 shows the control screen on the road profiles design parameter setting.

The numerical experiment results can be seen in Figure 5 until Figure 9. The control performance of the nonlinear active suspension system can be observed by sprung mass and angular of control arm. In Figure 5, the displacement of sprung mass can be observed based on the CCNF, LQR controller and passive system. The transient response of CCNF is the best control performance in order to reduce overshoot and fast response due to the nonlinearity of the active suspension system. In Figure 6, the CCNF again gave a good start response compared to LQR controller and passive system. As mentioned by C. S. and J. C. S. and J. C. S., the greater angle of angular displacement of control arm change, the greater the nonlinearity. Therefore, the CCNF is succeeded to reduce the overshoot simultaneously the nonlinearity of angular displacement of control arms also less.

In Figure 7, the velocity of sprung mass controlled by CCNF is the best transient performance. Due to the effect of a road profile as in Fig 4, LQR controller and passive system is unsuccessful to overcome the high overshoot. The same situation happened in angular velocity of control arms results shown in Figure 8. The CCNF controller gave the best control performance due to the high damping ratio to reduce overshoot in the response. The acceleration of sprung mass is referred to the ISO 2631 Table 1 as a guideline due to the human protection from the vibration noise. The results in Fig 9 show that the acceleration of sprung mass controlled by CCNF controller have the RMS vertical acceleration level 0.2858 m/s² reading put the degree of comfort in comfortable level compared to the LQR controller and passive system. The angular acceleration of control arms

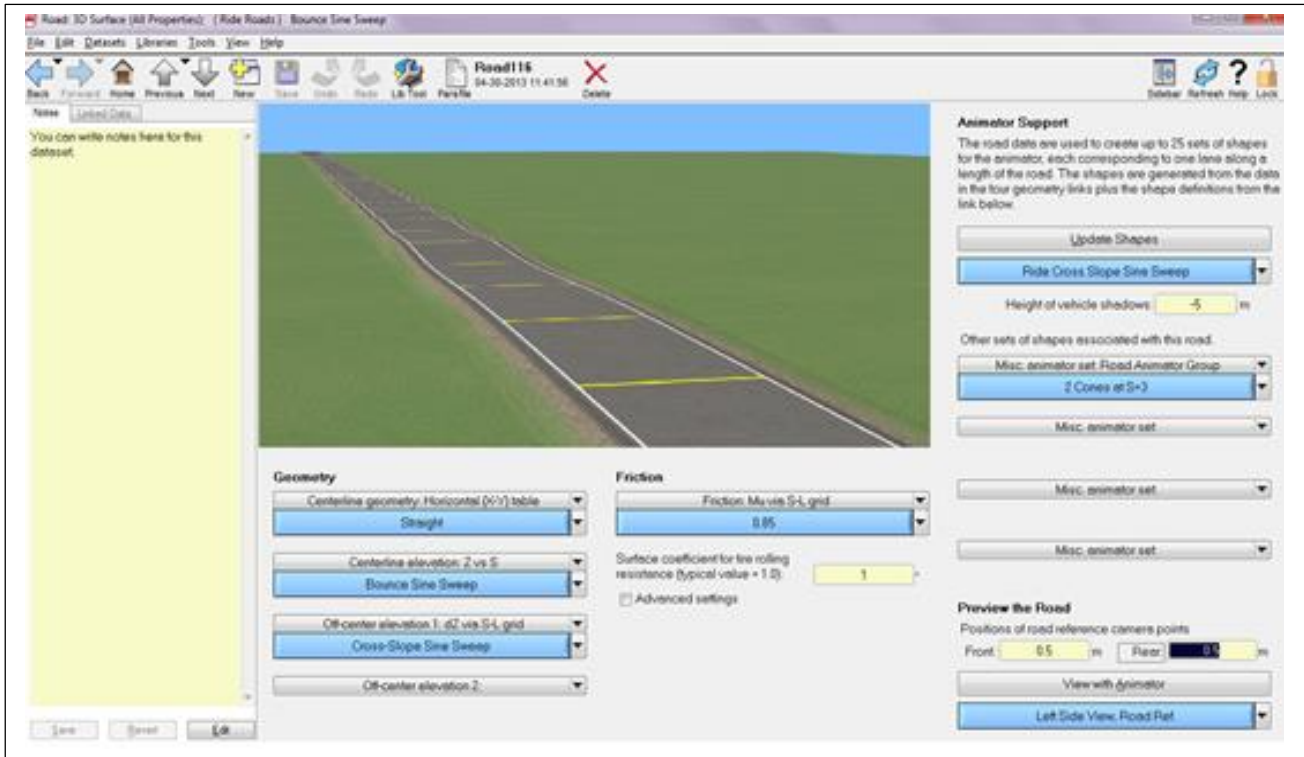

Figure 4 Control screen for road profile design

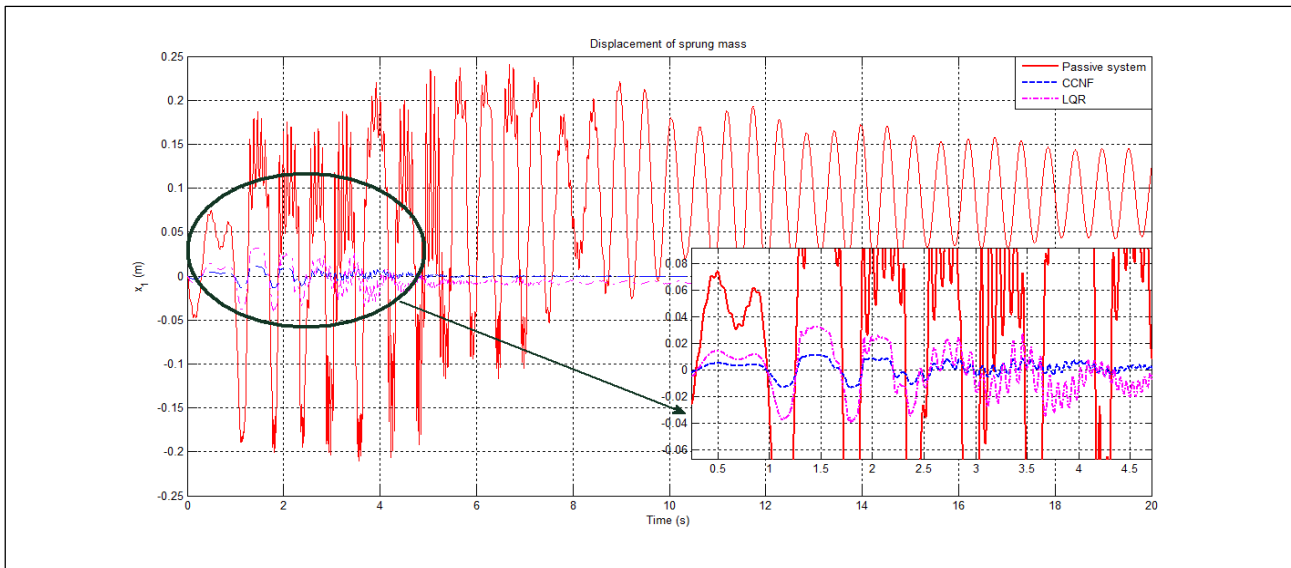

Figure 5 Displacement of sprung mass

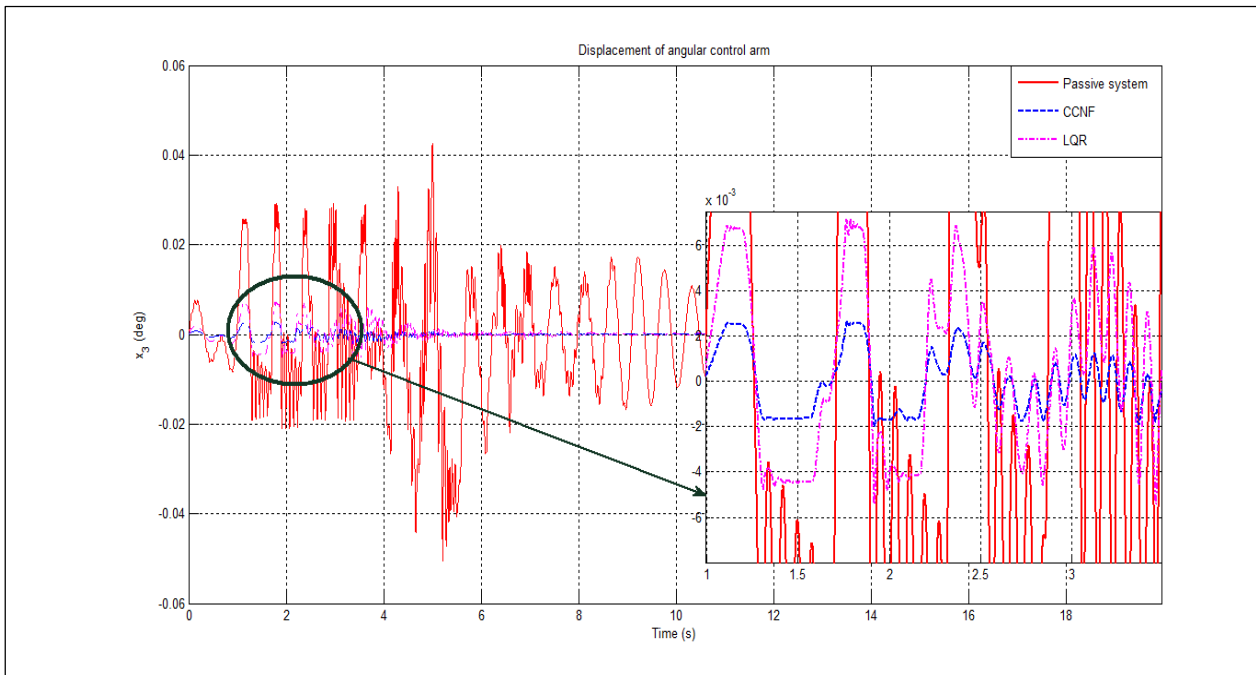

Figure 6 Angular displacement of control arm

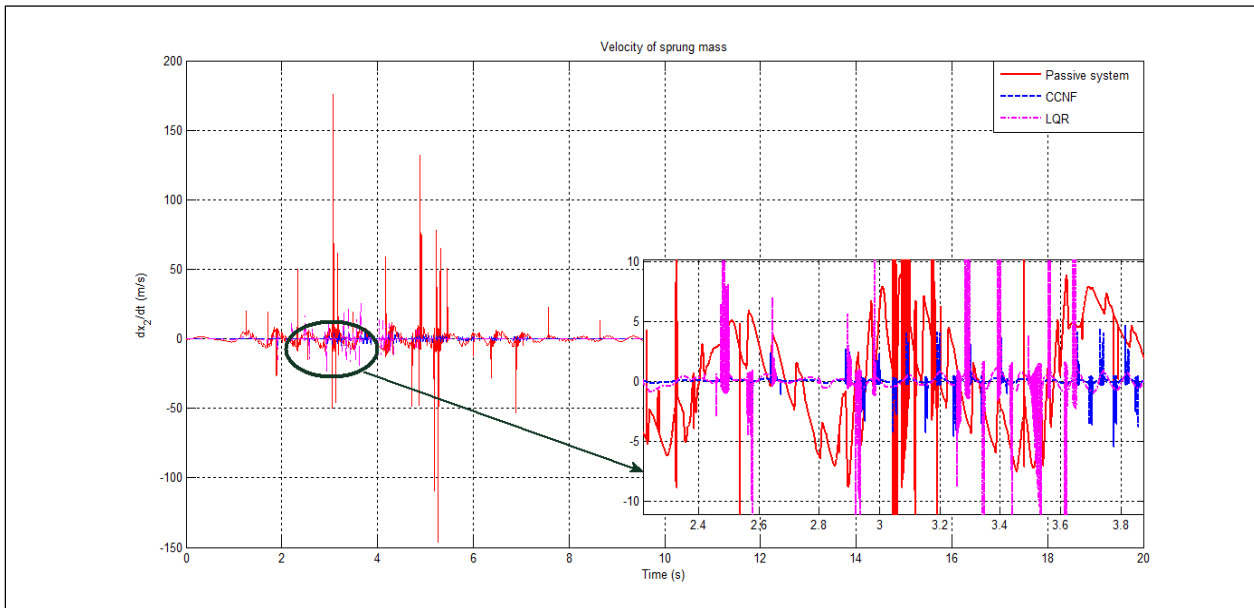

Figure 7 Velocity of sprung mass

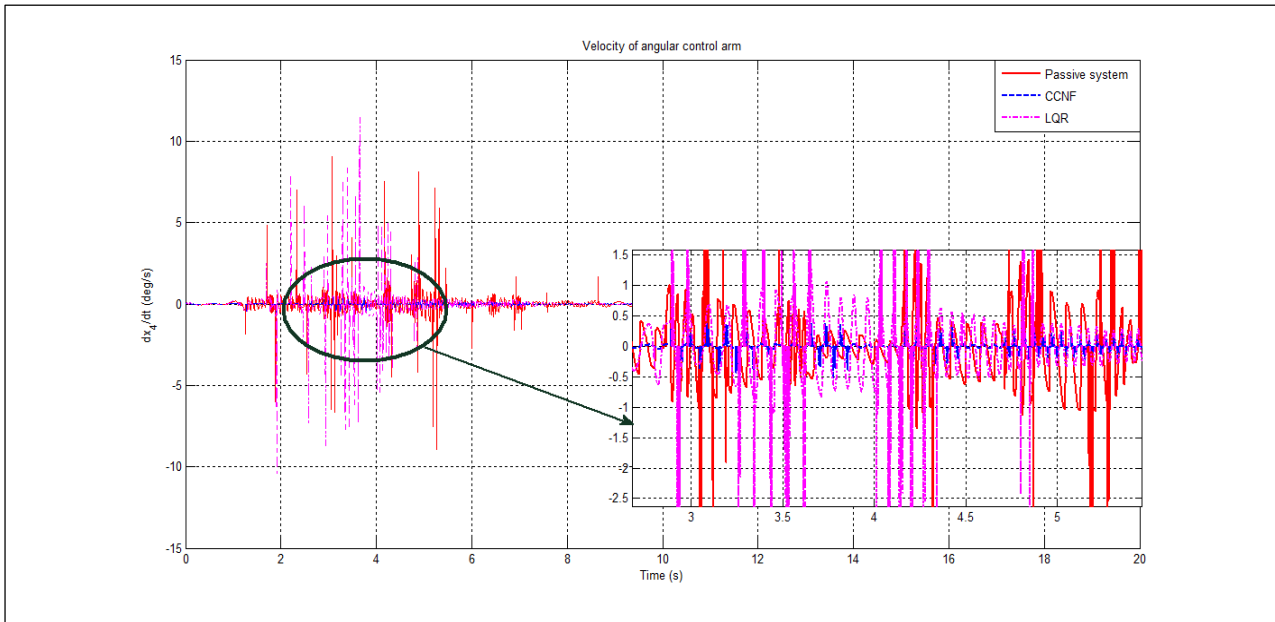

Figure 8 Angular velocity of control arm

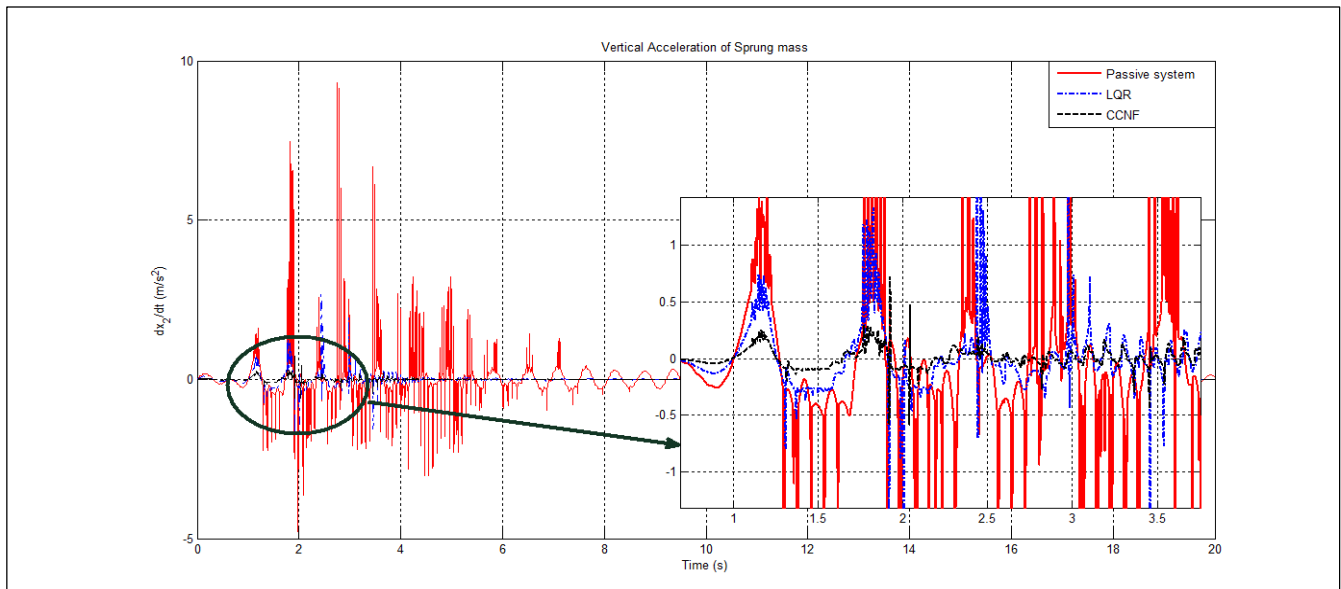

Figure 9 Vertical acceleration of sprung mass

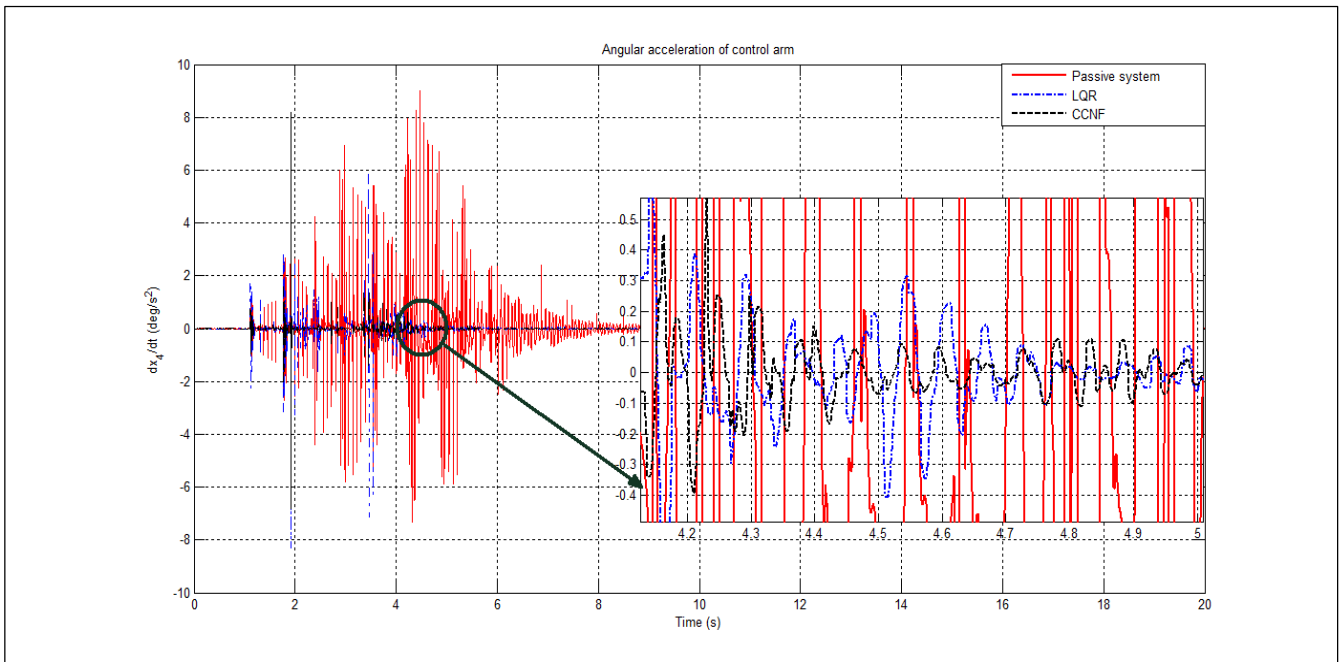

Figure 10 Angular acceleration of control arm

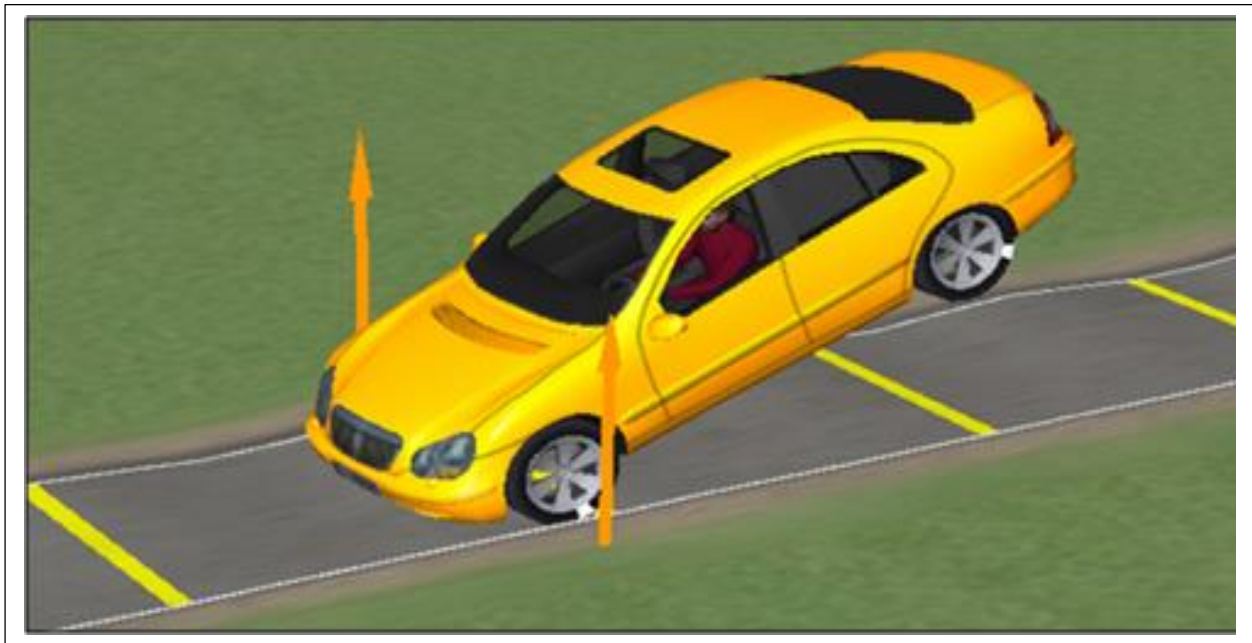

Figure 11 Virtual animation by Carsfor passive suspension system



Figure 12 Virtual animation by CarSim for active suspension system with CCNF

The effect of the control can be observed in Figure 7 and Figure 8. The car in Figure 7 is considered in terms of ride quality test and road handling performance. The car becomes unstable because of the effect on a passive suspension system without active force element. In Figure 8, the CCNF controller and LQR controller are successfully applied to the active suspension system. The different of control performance for both controllers can be evaluated from the results given from Figure 5 to Figure 10. The ride quality test and road handling performance made the car become stable at sine sweep profile as validation process using CarSim.

5.0 CONCLUSION

A CCNF controller designed is successfully applied to a nonlinear active suspension that resulted fast response and reduced overshoot. The results for each variable proved that control strategy of CCNF is the best control performance compared to the LQR controller and passive system. CarSim can be used as a validation tool for nonlinear active suspension system and prove the control performance in a virtual animation environment. The CarSim provided the best research tool for advanced automotive control system research field.

Acknowledgement

The authors would like to thank Universiti Teknologi Malaysia (UTM), Universiti Kuala Lumpur (UniKL) and Ministry of Higher Education (MOHE) Malaysia for their support.

References

- [1] Lin Z, Pachter M, Banda S. 1998. Improvement of Tracking Performance Nonlinear Feedback Linear Systems. *Int J Control*. 70: 1-11.
- [2] G. Y. Cheng, K. M. Peng, B. M. Chen, and T. H. Lee. 2007. Improving transient performance in tracking general references using composite nonlinear feedback control and application to high speed XY table positioning mechanism. *IEEE Transactions on Industrial Electronics* 54: 1039-1051.
- [3] B. M. Chen, T. H. Lee, K. Peng, and V. Venkataramanan. 2006. *Disk Drive Servo Systems*. 2nd ed. Springer, London.
- [4] X. Yu and W. Lu. 2012. Optimal Composite Nonlinear Feedback Control for a Gantry Crane System. *Control Conference (CCC), 2012 31st Chinese*. 604-606.
- [5] D. Hrovat. 1997. Survey of Advanced Suspension Developments Related Optimal Control Applications. *Automatica* 33(10): 1781-1817.
- [6] M. F. Ismail, Y. M. Sam, K. Peng, M. K. Aripin, and N. Hamzah. 2012. A Control Performance of Linear Model and the Macpherson Model Active Suspension System Using Composite Nonlinear Feedback Control System. *Computing and Engineering (ICCSCE), 2012 IEEE International Conference*. 2-7.
- [7] M. F. Ismail, K. Peng, N. Hamzah, Y. M. Sam, M. K. Aripin, and M. H. Che Hasan. 2012. A linear Model of Quarter Car Active Suspension System Using Composite Nonlinear Feedback Control. *Research and Development (SCORed), 2012 IEEE Student Conference on*. 96-103.
- [8] Yahaya Md. Sarim and Johari Halim Shah Bin Osman. 2005. Modeling And Control of the Active Suspension System Using Proportional Integral Sliding Mode Approach. *Asian Journal of Control* 7(2): 91-98.
- [9] H. Du and N. Zhang. 2007. Control of Active Vehicle Suspensions with Actuator Time Delay. *Journal of Sound and Vibration* 30(1): 236-252.
- [10] A. Abu-Khudhair, R. Muresan, and S. X. Yang. 2009. Control of Semi-Active Suspension. 2009 IEEE International Conference on Mechatronics and Automation, 7th Conference Proceeding. 2118-2122.
- [11] K.-S. Hong, D.S. Jeon, W.S. Yoo, H. Sunwoo, S. Shin, C.-M. Kim, and B.-S. Park. 1999. New Model and Optimal Pole Placement Control of the Macpherson Suspension System of Automotive Engineer.
- [12] X. Zhao, M. Kremb, and C. Schindler. 2013. Assessment of Wheel Loader Vibration on the Riding Comfort According to ISO Standards. *Vehicle System Dynamics* 51: 1548-1567.
- [13] X. D. Xue, K. W. E. Cheng, Z. Zhang, J. K. Lin, D. H. Wang, Y. B. M. K. Wong, and N. Cheung. 2011. Study of art of automotive active

- suspensions. In Power Electronics Systems and Applications (PESA), 2011 4th International Conference on, 1-7.
- [14] C. Sandu, E. R. Andersen, and S. Southward. 2010. Body Dynamics Modelling and System Identification for a Quarter Car Test Rig with McPherson Strut Suspension. *Vehicle System Dynamics* 49:153-179.
- [15] T. Shim and P. C. Velusamy. 2010. Improvement of Vehicle Roll Stability by Varying Suspension Properties. *Vehicle System Dynamics* 49:129-152.
- [16] B.-C. Chen, Y.-H. Shiu, and F. C. Hsieh. 2010. Sliding mode Control for Semi-active Suspension with Actuator Dynamics. *Vehicle System Dynamics* 49:277-290.
- [17] W. Jun, D. A. Wilson, X. Wenli, and D. A. Crolla. 2005. Active Suspension Control to Improve Vehicle Ride and Steady Handling. In Decision and Control, 2005 and 2005 European Control Conference CDC-ECC '05. 44th IEEE Conference on, 2198-7.
- [18] M. Kaleemullah, W. F. Faris, and F. Hasbullah. 2011. Design of R-H-Infinity, Fuzzy and LQR Controller for Active Suspension of a Quarter Car Model. In Mechatronics (ICOM), 2011 4th International Conference on, 1-6.
- [19] K. Chen and D. G. Beale. 2003. Base Dynamic Parameter Estimation of a MacPherson Suspension Mechanism. *Vehicle System Dynamics* 39:227-244.
- [20] M. B. A. Abdelhady. 2003. Fuzzy Controller for Automotive Active Suspension System.
- [21] Y. Watanabe and R. S. Sharp. 1992. Mechanical and Control Design of a Variable Geometry Active Suspension System. *Vehicle System Dynamics* 32:217-235.
- [22] F. Yu and D. A. Crolla. 1998. State Observer Design for an Adaptive Vehicle Suspension. *Vehicle System Dynamics* 30:457-471.
- [23] F. Yu and D. A. Crolla. 1996. Optimal Self-tuning Controller for an Active Suspension. *Vehicle System Dynamics* 29:51-65.
- [24] D. C. Chen and D. A. Crolla. 1998. Subjective and Objective Measures Of Vehicle Handling Drivers & Experiments. *Vehicle System Dynamics* 29:576-597.
- [25] L. Jung-Shan and I. Kanellakopoulos. 1997. Linear Design of Active Suspensions. *Control Systems, IEEE*: 45-59.